



QMS  
ISO 9001:2000  
JSA-001  
JSA-002



QMS Accreditation  
JAB-001



TTM-204

# TTM-200

DIGITAL CONTROLLER



TTM-204 (Gray)



TTM-204 (Black)



TTM-207



TTM-205



TTM-209

TOHO ELECTRONICS INC.

# DIGITAL CONTROLLER TTM-200

## ■ Features

### ● Improvement of the controllability with new PID algorithm

- ① Time until it is stabilized from a control start is shortened
- ② Loading the jump less control which controls the overshoot after the disturbance
- ③ You can choose from three kind of PID control that can be chosen

### ● Full multiple inputs

Established the input specification to be one type of the thermocouple (13 types), the platinum resistance temperature sensor (2 types), voltage (5 types) and the electric current (1 type). (Modification of setting with parameter)

### ● Sampling period

Realized acceleration in 200mS

### ● Utilizes a liquid crystal display

- ① The indication range has been extended to present 5 columns
- ② Actualized the various indication with 11 segments
- ③ Adopted LED to back light

### ● PV color auto-change

Display color of Process value (PV) can be optionally set from Red, Orange and Green as compare with Setting value (SV).

### ● Compact size

Depth is compact size, TTM-204 is only 55mm, and TTM-205, 207 and 209 are also only 65mm.

### ● Loader communication function

The best for the setup work of a parameter  
Cable: Option (sold separately)  
Software: Free option ---- It can download from our web site

### ● Abundant output type

Relay contact, SSR-driving, Open collector, Voltage (5 types) and Electric current

### ● Substantial option function

① CT input (Max. of 2 points) ② Event input (Max. of 4 points) ③ Event output (Max. of 7 points. However, when 7 points are used, you can not use the control output.)

### ● External standards

We have acquired "CE", "UL" and cUL.

### ● Protection structure (Available only for TTM-204)

Corresponding to "IP66"

### ● Valve position proportionality control

The function carries out valve position proportionality control without feedback resistance.

### ● Two choices of case colors (Available only for TTM-204)

"Black" or "Gray" choice is possible to preference

### ● Blind function

The system can be configured so that only specific, selected parameters are displayed from set of parameters.

### ● Simple timer function (independent three points)

The order of "After the defined time period passes, the control starts or stops" can be controlled by one unit.  
Also use by the timer independent is possible. (Event output ON/OFF)

### ● Priority screen

Without showing a parameter screen, a display and a setup can be performed by indicating a necessary parameter screen on the operation mode screen.  
(Maximum of 16 screens)

### ● Digital PV filter

Corresponding to the sudden change of input value, it can apply the filter with the software

### ● Manual control

A manual output function enables application of various instrumentation systems

### ● Communication function (RS485: An exclusive protocol / MODBUS)

The range extends up to the distance of 500m, and can connect up to 31 units concurrently.

With one host computer, it can remote consolidate watching "The collection of the data" and "Change of each setting value" at the place where it is far.

### ● Soft-start function

When the power supply is turned on, limitation can be put on manipulated value during specific time in PID control.

### ● Delay timer (Available only ON/OFF control)

It is possible to make the action of control output (Main or auxiliary) delay during specific time (setting).

### ● Auto/Manual control change

It is possible to change Auto/Manual control and also manipulated value from front panel keys by using FUNC function.

## ■ Front Panel

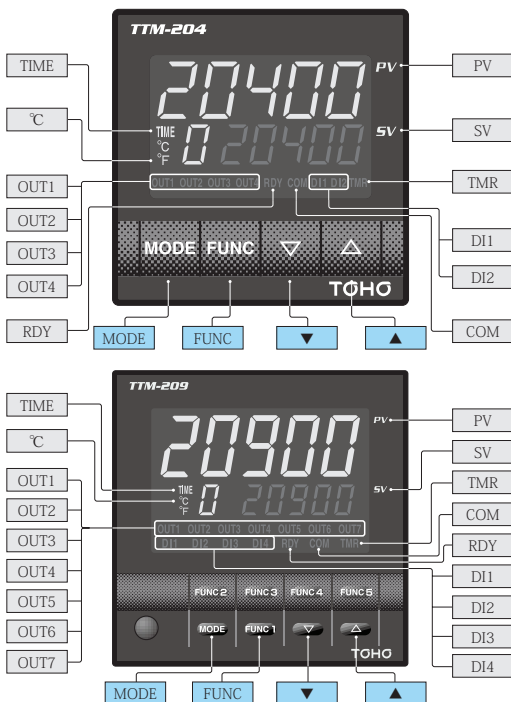

OUT1	Output 1 monitor (It appears when output)
OUT2	Output2 monitor (It appears when output)
OUT3	Output3 monitor (It appears when output)
OUT4	Output4 monitor (It appears when output)
OUT5	Output5 monitor (It appears when output)
OUT6	Output6 monitor (It appears when output)
OUT7	Output7 monitor (It appears when output)
RDY	RDY lamp (It appears in the state of Ready)
COM	COM lamp (It blinks during communication)
DI1	DI1 monitor (It appears when DI1 operates)
DI2	DI2 monitor (It appears when DI2 operates)
DI3	DI3 monitor (It appears when DI3 operates)
DI4	DI4 monitor (It appears when DI4 operates)
TMR	TIMER lamp (It appears when timer operates)
TIME	It appears when the setting is "Timer"
°C/°F	It appears when the setting is "Temperature"
PV	Measured value indication, Character indication, Timer set-up time indication
SV	Set value indication, Operation quantity indication, Timer remaining time indication
MODE	Mode key It is used when changing a screen.
FUNC	Function key It executes the function that is set
▲	Up key It is used when making a setting value increase It is used when changing input setting mode
▼	Down Key It is used when making a setting value decrease It is used when changing parameter screen

\*OUT6 is not available for TTM-207.

## ■ Operation flow

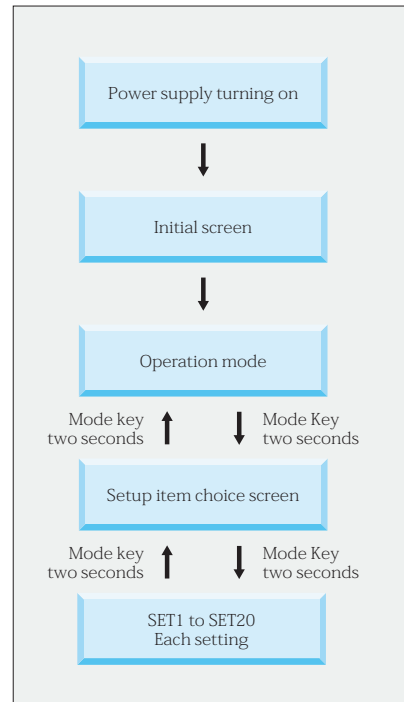

## Standard specification

Input type	Thermocouple	K, J, T, E, R, S, B, N, U, L, WRe5-26, PR40-20, PLII (Input resistance 1MΩ)			
	RTD	Pt100, JPt100			
	Electric current / voltage	4 to 20mA DC (Input resistance 250Ω), 0 to 1VDC, 0 to 5VDC, 1 to 5VDC, 0 to 10VDC, 0 to 10mVDC (Input resistance 1MΩ or more)			
Indication (LCD Indication)	PV/Character indication	LCD indication (with LED back light, luminous colors are Red, Orange and Green) TTM-204/205 5 digits, height 10mm TTM-207 5 digits, height 13mm TTM-209 5 digits, height 20mm			
	SV/Setting indication	LCD indication (with LED back light, luminous color is Red) TTM-204/205 5 digits, height 8mm TTM-207 5 digits, height 8mm TTM-209 5 digits, height 10mm			
	Auxiliary indication part	LCD indication (with LED back light, luminous color is Green) TTM-204/205 1 digit, height 8mm TTM-207 1 digit, height 8mm TTM-209 1 digit, height 10mm			
	Each functional indication	Red (OUT1, OUT2, OUT3, OUT4, OUT5, OUT6, OUT7, DRY, COM, DI1, DI2, DI3, DI4, TMR)			
	PV color auto-change	Luminous color	Red, Orange and Green		
Control	PID (With auto tuning) (With self tuning)	Proportional band (P1)	0.1 to 200.0% of set limiter span		
		Proportional band side of Output 2 (P2)	0.10 to 10.00 times (Per main control proportional band)		
		Integration time (I)	0 to 3600seconds (with "0" integral action OFF)		
		Differentiation time (D)	0 to 3600seconds (with "0" derivative control action OFF)		
		Proportion cycle (T1, T2)	0.1 to 120.0 seconds		
	ON/OFF	Control sensitivity (C1, C2)	Dead band (DB)	Temperature input	-999.9 to 999.9 or -999 to 999 (°C)
			Analog input	-9999 to 9999 (digits) (The decimal point position is the specified position.)	
			Temperature input	0.0 to 999.9 or 0 to 999 (°C)	
	Output 1 and 2 Off point	Position selection setting	Analog input	0 to 9999 (digits) (The decimal point position is the specified position.)	
			Position setting	SV unit setting High/Medium/Low	
Control output	Relay contact	250VAC 3A (Resistance load) 1a contact point Minimum load 5VDC 100mA			
	SSR-driving voltage	0 to 12VDC (Load resistance 600Ω or more)			
	Open collector	24VDC 100mA			
	Current / voltage	4 to 20mA DC (Load resistance 600Ω or less)			
	Voltage	0 to 1VDC (Load resistance 500KΩ or more), 0 to 5VDC (Load resistance 1KΩ or more), 1 to 5VDC (Load resistance 1KΩ or more) 0 to 10VDC (Load resistance 1KΩ or more), 0 to 10mVDC (Load resistance 500KΩ or more)			
Sampling cycle	0.2 seconds				
Setting and instruction accuracy (In ambient temperature 23°C ± 10 degree)	Thermocouple	K, J, T, E, R, S, B, N	Larger one ± (0.3%+1 digit) of the instruction value or ± 2°C (23°C ± 10°C) However, -100 to 0°C is ± 3°C, and -200 to -100°C is ± 4°C. As for 400°C or less of B thermocouple there is no stipulation		
		U, L	Larger one ± (0.3%+1 digit) of the instruction value or ± 4°C (23°C ± 10°C) Less than 0°C is ± 6°C.		
		WRe5-26 PR40-20 PLII	Larger one ± (0.6%+1 digit) of the instruction value or ± 4°C (23°C ± 10°C) ± 9.4°C ± 1 digit. There is no precision stipulation under 800°C Larger one ± (0.3%+1 digit) of the instruction value or ± 2°C		
	RTD	Pt100, JPt100	Larger one ± (0.3%+1 digit) of the instruction value or ± 0.9°C (23°C ± 10°C)		
		Current/voltage	0 to 1VDC, 0 to 5VDC 1 to 5VDC, 0 to 10VDC, 4 to 20mA DC 0 to 10mVDC ± 0.3% ± 1 digit of set limiter span (23°C ± 10°C) ± 0.5% ± 1 digit of set limiter span (23°C ± 10°C)		
Memory element	EEPROM				
Input power supply	100 to 240VAC, 50/60Hz, 24VAC/DC 50/60Hz				
Weight	TTM-204 : 120g TTM-205 : 210g TTM-207 : 260g TTM-209 : 300g				
Power consumption	TTM-204 less than 10VA (100 to 240VAC), less than 4W (24VAC/DC), TTM-205/207/209 less than 11VA (100 to 240VAC), less than 5W (24VAC/DC)				
Accessories	Simple instruction manual and Attachment (A handling description is sold separately.)				
Standard Range of surrounding temperature humidity (Compensating range such as precision)	23°C ± 10°C, 45 to 75% RH				
Range of use surroundings temperature humidity	0 to 50°C, 20 to 90% RH (Avoid dewiness)				
Range of preservation surroundings temperature humidity	-20 to 70°C (Avoid dewiness and freezing), 5 to 95% RH (Avoid dewiness)				
Function	Manipulated variable limiter (MLH1, MLL1, MLH2, MLL2)	Upper limit (MLH1, MLH2)	Digital output	MLL1 to 100.0 (%), MLL2 to 100.0 (%)	
			Analogue output	MLL1 to 110.0 (%), MLL2 to 110.0 (%)	
		Lower limit (MLL1, MLL2)	Digital output	0.0 to MLH1 (%), 0.0 to MLH2 (%)	
			Analogue output	-10.0 to MLH1 (%), -10.0 to MLH2 (%)	
	Upper limit lower limit setting of manipulated variable change limiter	0.0 to 549.9 (%) (Function OFF by 0.0%)			
	Abnormal time manipulated variable setting	Digital output	0.0 to 100.0 (%)		
		Analog output	-10.0 to 110.0 (%)		
	Setting limiter (SLL, SLH)	Upper limit (SLH)	Temperature input	(SLL + 5.0) to SV setting range upper limit, (SLL + 5) to SV setting range upper limit (°C)	
			Analogue input	(SLL + 5.0) to SV setting range upper limit (digit)	
		Lower limit (SLL)	Temperature input	SV setting range lower limit to (SLH - 5.0), SV setting range lower limit to (SLH - 5) (°C)	
	Control mode (MD) Control types (CNT)	PID type	Analogue input	SV setting range lower limit to (SLH - 50) (digit)	
			Control stop, control beginning, manual control, timer1 operation, timer2 operation, and timer3 operation		
			Type A (Normal PID control type) Type B (Over-shoot protection type) Type C (External disturbance protection type)		
		Type B mode	Over-shoot protection Weak Over-shoot protection Middle Over-shoot protection Strong		
	Normal reverse action setting	Reverse action			
Normal action					
Tuning type setting	Main auto-tuning (Main PID/position proportionality control) Main self-tuning (Main PID/position proportionality control) Auxiliary auto-tuning (Main PID/auxiliary PID) Auxiliary self-tuning (Main PID/auxiliary PID) Main/auxiliary auto-tuning (Main PID/auxiliary PID)				
	Output gain setting (MV1G, MV2G)	0.0 to 1000.0 (%)			
	PV correction, 0 point setting (PVS)	Temperature input	-999.9 to 999.9 (°C)		
		Analog input	-9999 to 9999 (digit)		
PV correction, gain setting (PVG)	0.500 to 2.000 (times)				
PV input filter (PD)	0.0 to 99.9 (seconds)				
Anti reset windup	0.0 to 110.0 (%) (Function OFF by 110.0% setting)				
Manual reset (PBB)	0.0 to 100.0 (%) (-100.0 to 100.0%) if there is auxiliary control				
Loop abnormal time setting	Main control loop abnormal time setting	0 to 9999 (seconds)			
	Auxiliary control loop abnormal time setting	0 to 9999 (seconds)			

## Standard specification

Function	Timer driving mode (TMF)	Three points. 0 minute and 00 second to 99 minutes and 59 seconds. 0 hour and 00 minute to 99 hours and 59 minutes. Timer repetition frequency: 0 to 99 times (With 0 unlimited frequency) Accuracy: $\pm (1.5\% + 0.5 \text{ seconds})$ of setting time Function: Auto start, Manual start, Event start, SV start, DI start		
	Delay timer (FDT)	0 to 99 (minutes) Main/auxiliary common		
	Decimal point movement (DP)	Indication below decimal point. Yes/No		
	Manual control	Manual control is possible. (Balance-less / Bump-less)		
	RUN/READY	Switching of RUN/READY is possible.		
	Blind function	An optional parameter screen can be set up in the non-indication.		
	Auto tuning coefficient (ATG)	0.1 to 10.0 times		
	Auto tuning sensitivity (ATC)	Temperature input	0.0 to 999.9 or 0 to 999 (°C)	
		Analog input	0 to 9999 (digits)	
	Function key	A function key can be chosen from "Figure movement", "MD/ready", "AT start/stop", "Timer start/reset", "Reverse screen turning", "ENT", "Bank change" and "Auto/manual change". Settlement of push time (0 to 5 seconds)		
	Priority screen	An optional parameter screen can be indicated in the operation mode. (Maximum of 16 points)		
	Lock function (LOC)	Four modes (OFF, ALL Lock, Operation mode lock, and lock except operation mode)		
	Self-diagnostic function	EEPROM data check (Err0), A/D converter action check (Err1), auto-tuning check (Err2), watch-dog timer equipped		
	Ramp function	Action	When modify SV, set up the SV variation per minute	
		Setting range	Temperature input	0.0 to 999.9 (Ramp function turns OFF by 0.0)
			Analog input	????????????????????
		Setting unit	Temperature input	0.1°C/minute
	Analog input		0.1 digit/minute	
	Valve function	Motor stroke time	0.1 to 999.9 (seconds)	
		Motor drive dead band	0.0 to 100.0 (seconds)	
Initialization mode	Password setup, blind screen one time call setup, setting value backup and set value initialization Since a password is required for this mode when making a setting change, please be sure to keep the password.			
Bank setting	Setting the parameter of set 1 to 17 (A maximum of 16 points)			
Soft-start (Main control)	Output setting	MLL1 to MLH1 (%)		
	Time setting	00:00 to 99:59 (minutes), Function OFF by 00:00 (minutes)		

## Option specification

Auxiliary output (2 points) (Common Terminal)	Relay contact	250VAC 1A (resistance load) 1a contact point		
	Open collector	24VDC 100mA		
	Setting range (Upper and Lower limit)	Temperature input	-1999.9 to 2999.9, -19999 to 29999 (°C)	
		Analog input	-19999 to 29999 (digit)	
	Sensitivity	Temperature input	0.0 to 999.9, 0 to 9999 (°C)	
		Analog input	0 to 9999 (digit)	
Delay timer	0 to 9999 (seconds)			
DI input (Max. 4 points)	Function	Bank switch, RUN/READY switch (At the time of contact point closing is Ready), Auto/Manual switch (At the time of contact point closing is Manual), Reverse action/Forward action switch (At the time of contact point closing is Forward action) Auto tuning STOP/START (At the time of contact point closing is Auto tuning Start), Timer STOP/START (At the time of contact point closing START)		
	Input specification	No voltage contact point. Active switching is possible at the time of the input.		
	Minimum input time	200mS		
	When ON electric current	Maximum 10mADC		
	When OFF electric current	Maximum 6VDC		
	Terminal permission resistance	When ON: Maximum 333Ω. When OFF: Minimum 500KΩ		
CT input (2 points)	Measurement electric current range	0.0 to 50.0A		
	Setting electric current range	0.0 to 30.0A (Setting resolution 0.1A). However, the function is turning off at 0.0.		
	Setting accuracy	$\pm 5\%$ (0.1A or less is outside accuracy)		
	Wire break detection	ON time of control output above 300mS		
	Welding detection	OFF time of control output above 300mS		
	Communication	Communication	Loader communication	
Communication	Communication standard	RS-485 (1.31)	TTL (1:1)	
	Communication terminal	Terminal stand	Loader communication private terminal	
	Protocol	TOHO exclusive protocol/MODBUS (RTU)/MODBUS (ASCII)	TOHO exclusive protocol/MODBUS (RTU)/MODBUS (ASCII)	
	Direction of information	Half duplex	Half duplex	
	Synchronous system	Asynchronous	Asynchronous	
	Transmission code	ASCII	ASCII	
	Interface	RS-485 (two lines)	TTL level	
	Transmission speed	2400, 4800, 9600, 19200, 38400bps	2400, 4800, 9600, 19200, 38400bps	
	Communication distance	500m		
	Response delay time	0 to 250mS	0 to 250mS	
	Communication switch	Writing is impossible/Writing is possible/Simultaneous temperature rise master/Simultaneous temperature rise slave.		
	Character	Start bit: 1 bit fixation	Start bit: 1 bit fixation	
		Stop bit: 1/2 bit	Stop bit: 1/2 bit	
		Data length: 7/8 bit * MODBUS: In case of ASCII --- 7 bits fixation In case of RTU --- 8 bits fixation	Data length: 7/8 bit * MODBUS: In case of ASCII --- 7 bits fixation In case of RTU --- 8 bits fixation	
		Parity: No/Even number/Odd number	Parity: No/Even number/Odd number	
		BCC check: No/Yes * In case of MODBUS --- BCC Check is invalid	BCC check: No/Yes * In case of MODBUS --- BCC Check is invalid	
		Address: 1 to 99 stations * In case of MODBUS --- 1 to 247 stations	Address: 1 to 99 stations * In case of MODBUS --- 1 to 247 stations	
Transmission output	Functional setting	PV (Process value) output, SV (Setting value) output, MV1 (Main manipulated variable) output, MV2 (Secondary manipulated variable) output. Reciprocal change possibility		
	Temperature input	Scaling low limit to 2999.9 (°C), scaling low limit to 2999 (°C)		
	Analogue input	Scaling low limit to 29999 (digit)		
	Temperature input	-1999.9 to scaling high limit (°C), -1999 to scaling high limit (°C)		
Analogue input	-19999 to scaling high limit (digit)			

## Input and scale range

Thermocouple		Measurement/measurement range	Indication resolution
K	°C	-200.0 to 1372.0	1°C/0.1°C
J	°C	-200.0 to 1200.0	1°C/0.1°C
T	°C	-200.0 to 400.0	1°C/0.1°C
E	°C	-200.0 to 1000.0	1°C/0.1°C
R	°C	-50.0 to 1768.0	1°C
S	°C	-50.0 to 1768.0	1°C
B	°C	-0.0 to 1800.0	1°C
N	°C	-200.0 to 1300.0	1°C/0.1°C
U	°C	-200.0 to 400.0	1°C/0.1°C
L	°C	-200.0 to 900.0	1°C/0.1°C
WRe5-26	°C	0.0 to 2300.0	1°C
PR40-20	°C	0.0 to 1880.0	1°C
PL II	°C	0.0 to 1390.0	1°C/0.1°C

RTD		Measurement/measurement range	Indication resolution
Pt100 (JIS/IEC)	°C	-200.0 to 850.0	1°C/0.1°C
JPt100 (JIS)	°C	-200.0 to 510.0	1°C/0.1°C

Current and voltage	Measurement/measurement range	Indication resolution
0 to 1VDC	-19999 to 29999 Indication width is less than 20000.	A decimal point position can be changed arbitrarily.
0 to 5VDC		
1 to 5VDC		
0 to 10VDC		
0 to 10mVDC		
4 to 20mADC		

## Output connection setting

Main output
Auxiliary output
Event output
RUN output
RDY output
Timer1 output
Timer1 output at on delay
Timer1 output at off delay
Timer1 output at on + off delay
Timer2 output
Timer2 output at on delay
Timer2 output at off delay
Timer2 output at on + off delay
Timer3 output
Timer3 output at on delay
Timer3 output at off delay
Timer3 output at on + off delay
Transmission output (When OUT1 and OUT2 are analogue output)

## Timer drive mode

### Start mode

1	Auto start
2	Manual start
3	SV start
4	DI1 start (Possible to set when option is equipped)
5	DI2 start (Possible to set when option is equipped)
6	DI3 start (Possible to set when option is equipped)
7	DI4 start (Possible to set when option is equipped)
8	Event 1 start
9	Event 2 start
10	Event 3 start (Possible to set when option is equipped)
11	Event 4 start (Possible to set when option is equipped)
12	Event 5 start (Possible to set when option is equipped)
13	Event 6 start (Possible to set when option is equipped)
14	Event 7 start (Possible to set when option is equipped)

\* Each Start has ON delay/OFF Delay

ON delay: After time-up control stop or event output OFF

OFF delay: After time-up control stop or event output ON

## Point of contact output mode

### Event function 1

Function	
0	No
1	Deflection upper and lower limit
2	Deflection upper limit
3	Deflection lower limit
4	Deflection range
5	Absolute value upper and lower limit
6	Absolute value upper limit
7	Absolute value lower limit
8	Absolute value range
Addition function	
0	No
1	Maintenance
2	Standby sequence
3	Delay timer
4	Maintenance + Standby sequence
5	Maintenance + Delay timer
6	Standby sequence + Delay timer
7	Maintenance + Standby sequence + Delay timer
Control linkage function	
0	All mode
1	RUN/MAN mode only
2	RUN mode only

### Event function 2 (PV abnormal)

Function	
0	No
1	Exist
Addition function	
0	No
1	Maintenance
2	Delay timer
3	Maintenance + Delay timer
Control linkage function	
0	All mode
1	RUN/MAN mode only
2	RUN mode only

### Event function 3 (CT abnormal)

Function	
0	No
1	CT1 abnormal
2	CT2 abnormal
3	CT1 abnormal + CT2 abnormal
Addition function	
0	No
1	Maintenance
2	Delay timer
3	Maintenance + Delay timer
Control linkage function	
0	All mode
1	RUN/MAN mode only
2	RUN mode only

### Event function 4 (Loop wire break)

Function	
0	No
1	Exist
Addition function	
0	No
1	Exist

\*Event polarity function available

## Output functional allotment (○: Allotment is possible, ×: Allotment impossibility)

Output types	Control output		Auxiliary output				
	Output1	Output2	Output3	Output4	Output5	Output6	Output7
Main output (Heating)	○	○	○	○	○	○	○
Auxiliary output (Cooling)	○	○	○	○	○	○	○
Transmission	○	○	×	×	×	×	×
Event output	○	○	○	○	○	○	○
Timer output	○	○	○	○	○	○	○

## Terminal explanation

Communication	Please connect the terminal of A and B rightly. (Please use a converter when it is not RE-485)	
Output (Right reverse change is possible)	Relay point of contact	C: Common, No: Normal open
	SSR driving	Please connect directly with INPUT+ and - by the side of SSR.
	Transmission, Open collector	Please be connected to polarity of + and - with care
CT	Please connect a specified current transformer directly. (CTL-6-P-H)	
PV input/ AI input	Thermocouple	Please be connected to polarity of + and - with care
	Current/voltage	Please be connected to terminals A, B and b with care
DI	COM: Common (The polarity can be switched)	
AI input	Please be connected to polarity of + and - with care	

## Wiring

※Please use less than 6mm width terminal

### TTM-204

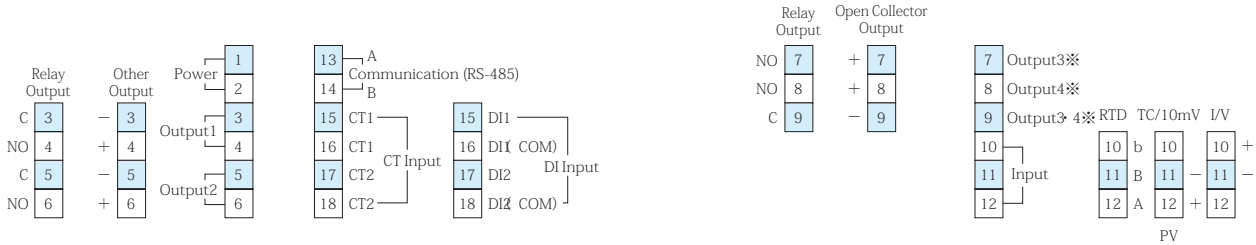

※ Output 3 and 4 (Terminals 7 to 9) are possible to select from either relay output or open collector.

### TTM-205, 209

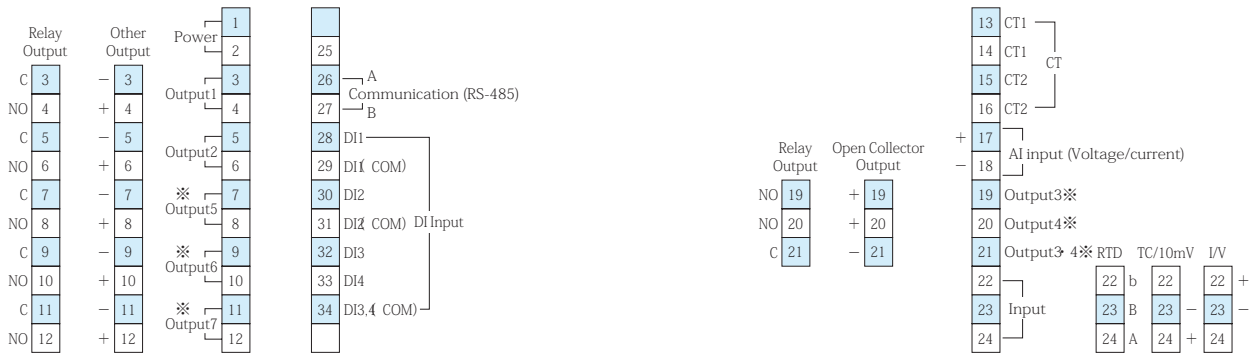

※ Output 3 to 7 (Terminals 19 to 21 and 7 to 12) are possible to select from either relay output or open collector.

### TTM-207

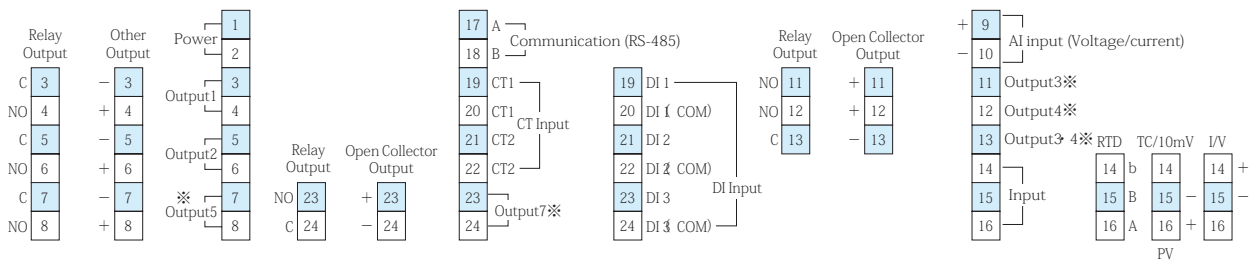

※ Output 3 to 5 and 7 (Terminals 11 to 13, 7 to 8, 23 to 24) are possible to select from either relay output or open collector.

## ■ Dimensions

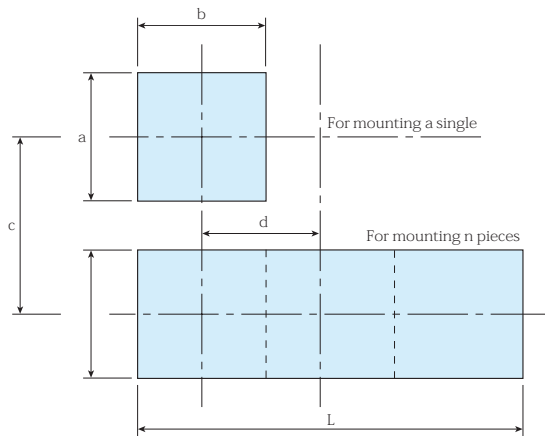
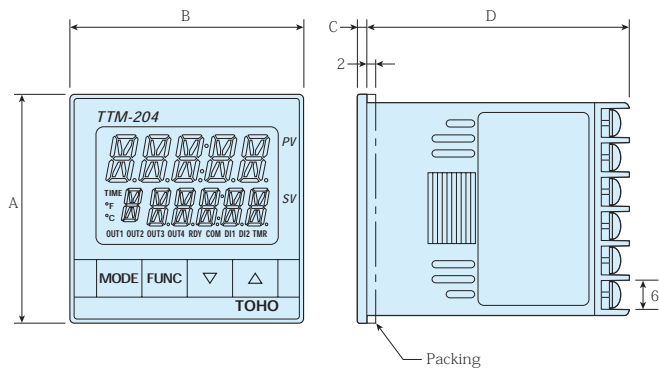

Model	a	b	c	d	A	B	C	D	L
TTM-204	45 +0.6 -0	45 +0.6 -0	60	48	48	48	2	55	( Bxn-3) +0.6 -0
TTM-205	92 +0.6 -0	45 +0.6 -0	120	48	96	48	2	65	( Bxn-3) +1 -0
TTM-207	68 +0.6 -0	68 +0.6 -0	90	72	72	72	2	65	( Bxn-3) +1 -0
TTM-209	92 +0.6 -0	92 +0.6 -0	120	96	96	96	2	65	( Bxn-3) +1 -0

## ■ Panel Installation

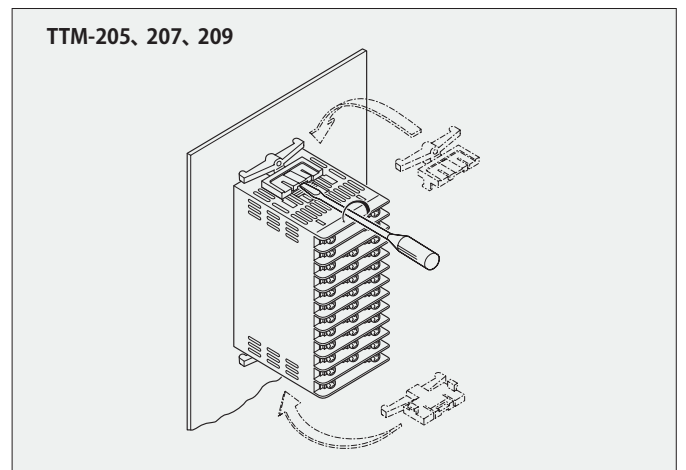
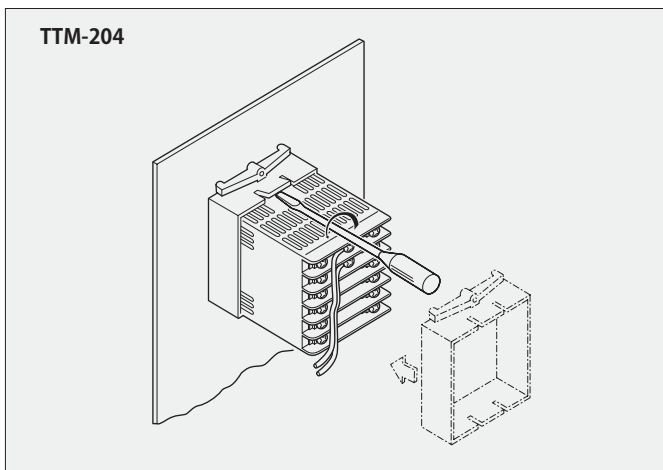

\* For this panel installation, please be careful sufficiently to avoid any of damage.

# Advanced Feature

## PID control by new algorithm

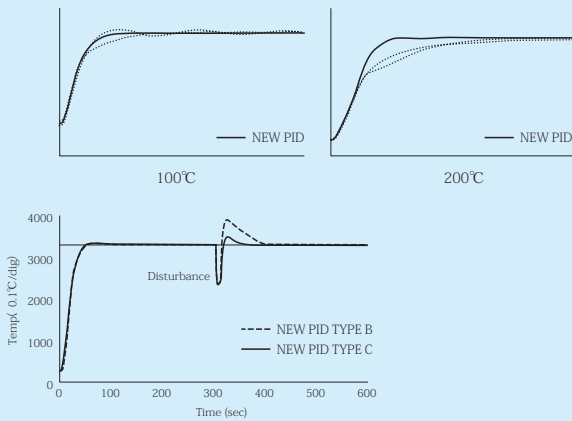

## BLIND Function Setting

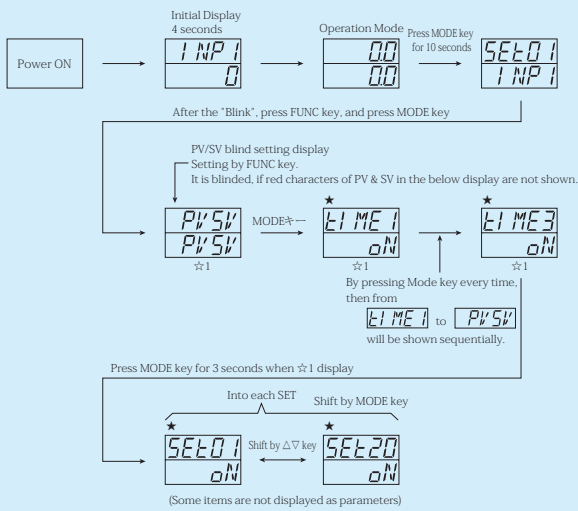

Content of the above ★

- 1) In BLIND MODE, either [ ON ] & [ OFF ] is displayed on under each characters (SV display). [ ON ] is displayed [ OFF ] is not displayed (BLIND).
- 2) To change characters in BLIND MODE by pressing [ FUNC ] key.
- 3) Power OFF for end of BLIND setting mode.

It is possible not to make the optional picture indicate by the key operation

In addition, please note that only measured value is displayed without displaying a setting value in the case of the usual display when the SV setup screen is turned off.

## Timer function

1. In the case of bread baking oven

- Put dough in the oven, and push the start key to the timer.
- The temperature is controlled by the heater and so on for the timer setup time.
- After timer count end control is stopped automatically (It is used when making control STOP after the timer count ends.)

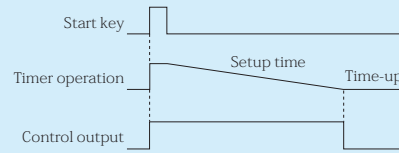

2. In case of packing machine and industrial machine, which control is started after the completing the preparation of the peripheral device

- The count of the timer begins from point that turns on the power supply.
- The control output stops during timer setting time
- The control starts automatically after the timer count ends. (It is used when making control starts after the timer count ends.)

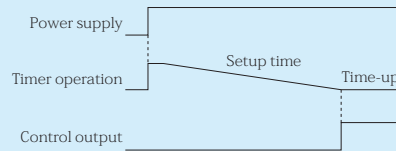

## Communication function

● A connection example with the personal computer

Centralized supervision with the personal computer is possible with the connection like the chart below.

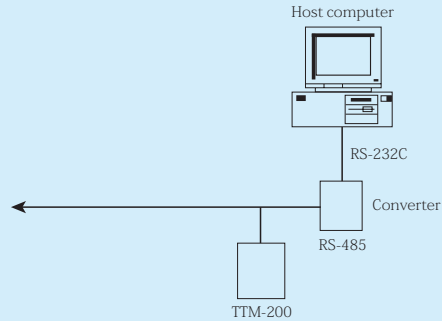

● Loader communication

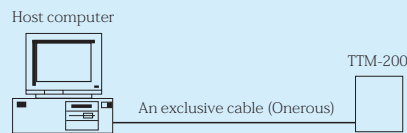

※Loader cable specification  
[Appearance and structure]

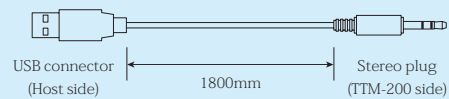

[Standard and performance]

USB I/F standard	USB Specification 2.0 Conforming
DTE (Personal computer side) speed	Up to 38400bps
Connector specification	Personal computer side: USB Temperature Controller side: φ 2.5mm Stereo plug

[ Model]

TTM-LOADER



### ●Digital PV filter

It is the function to realize the CR filter effect on the software by performing primary delay operation to the measured value (PV).

The effect of the filter can be set by the time constant.

(Time constant is the time that the PV value reaches up to about 63% when the input changes on the step.)

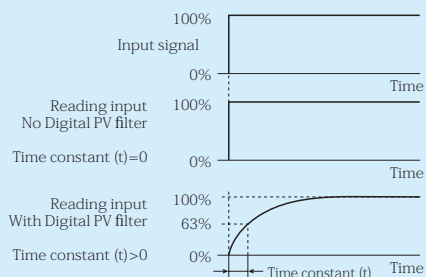

The use of Digital PV filter

- 1) Removal of high frequency noise --- The influence of a noise when an electric noise joining an input is mitigated.
- 2) A response can be delayed against the sudden change of the input.

### ●Self-tuning PID

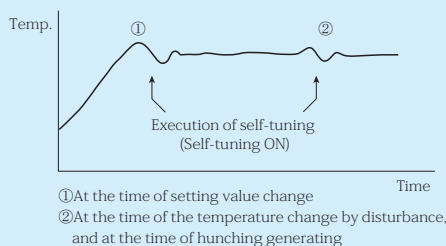

### ●Auto (RUN) / Manual function

The auto control and the manual control, they can be switched by the front key. Manual operation is the function that is not concerned with the situation of a deviation, but can set up and output the output for control arbitrarily (manipulation variable).

The system can be operated manually in the time of the system trial run and so on, when to check of final control element (a valve, heater, etc.) of operation is performed, when the sensor breaks down by any chance, or when usual control can't be done.

There is the Balance-less Bump-less function, which holds down sudden change of control output when switching the automatic control and manual control mutually. Furthermore, it stops damage on the peripheral equipment by sudden change and the bad influence to a control system. So, you can operate in comfort.

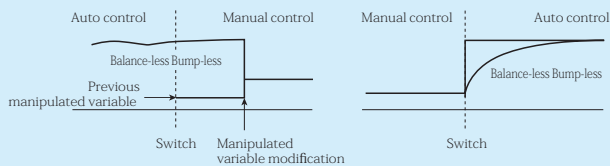

Balance-less Bump-less

### ●Ramp function

The ramp function is a matter of function made to have inclination against the change in SV (Setting value).

As actual operation, the setting value of a dummy is made to change gradually toward the setting value after changing. Then it controls to the setting value of the dummy.

The amount of change for around one minute of SV is set up.

When a rapid change of the control result is not allowed with the characteristic of the control subject, and when the change course (inclination) of the control result becomes important in a control subject, the effect of a ramp function is demonstrated, the effect of the ramp function is demonstrated.

In addition, since only SV is changed, the result expected may not be obtained when it expects great influence to PV (measured value).

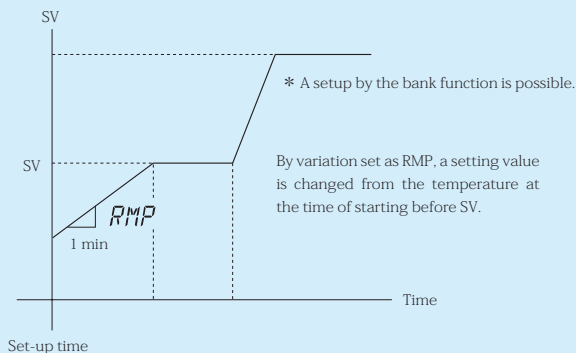

### ●OFF point position movement of ON/OFF control

When the OFF point position movement is set to 0, the OFF point is the set value position.

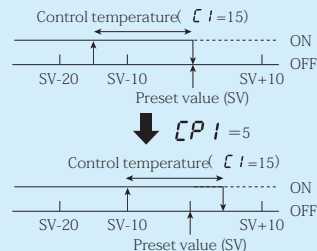

This is when off point position movement is set up with (+5).

Actually specification, there is no description change as above, but move above equal to (+5) as a position of ON/OFF.

Case it made move on negative side, the OFF point moves to opposite side to description above.

### ●Heating and cooling

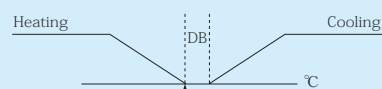

## ● Simultaneous temperature rise function

### ■ Simultaneous temperature rise

- When simultaneous temperature rise control is exerted by multi-channels using the RS-485 communication function, a master and slave are determined beforehand. This permits reaching the respective goal values at the same time regardless of the characteristic of each channel.

The channel, in which the time from the start of control to the reach to the goal value is the longest, is specified as a master. The other channels are specified as slaves.

- The simultaneous temperature rise function is started at the start of run (including the power ON time) or a change of setting value, and is ended when the master reaches the goal value.

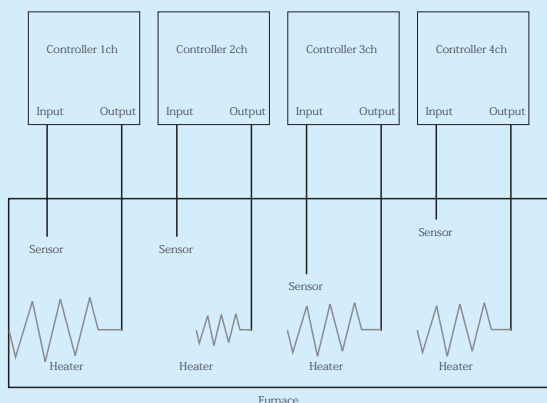

### ● How to use

- Perform communication protocol settings to the TOHO protocol.
- In the communication changeover setting, set the channel, in which the temperature reaches the goal value latest, to the simultaneous temperature rise master, and then set the other channels to the simultaneous temperature rise slaves.
- Set the main control sensitivity.

During a simultaneous temperature rise, the slave side exerts ON/OFF control for the current temperature of the master. Accordingly, set the sensitivity to a level that does not cause chattering.

### Note: Precautions on use

- Perform auto tuning for each channel as required.
- When using the simultaneous temperature rise function, do not perform communication with the outside.

## ● Bank function

8 banks each with 16 setting that can be changed as optional parameter.

A desired state can be reached by adjusting the bank setting, but without modifying the temperature setting or valve of the PID.

This can be done by setting up a parameter for an applicable bank that references the temperature control for one unit.

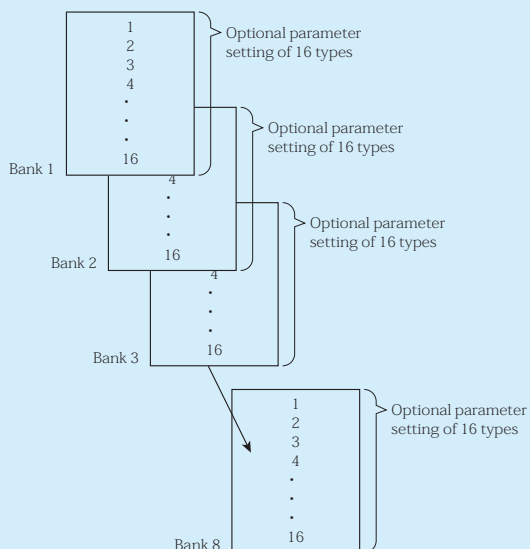

## ● Position proportional control

### ■ Position proportional control

- According to the operation amount required for PAD control, the valve opening is changed by outputting an open signal or close signal to the valve on the basis of the valve motor stroke time, so that the flow rate is adjusted, thereby controlling the target temperature. The control can be exerted without feedback resistance.
- The valve motor stroke time means the time from the full opening of the valve till its full closing.

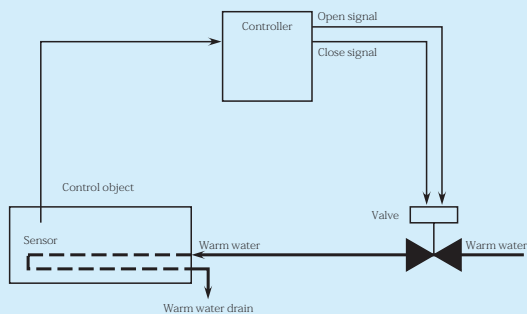

### ● Valve motor drive dead band

In position proportional control, the open signal or close signal is output so that the operation amount of the regulator may agree with the opening of the valve.

It is necessary to refrain from performing an open/close changeover operation frequently in consideration of the service life of the valve.

A dead band is provided at the open signal/close signal output changeover point.

In this area, both open signal output and close signal output are stopped to reduce frequent open/close changeover operations.

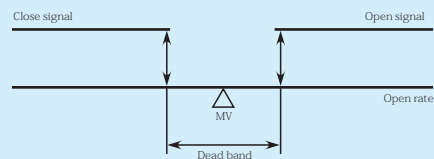

### ● Initial opening after the end of AT

It is possible to set the operation amount just after the end of auto tuning in order to restrict undershoot just after this end.

Example) Response after the end of AT

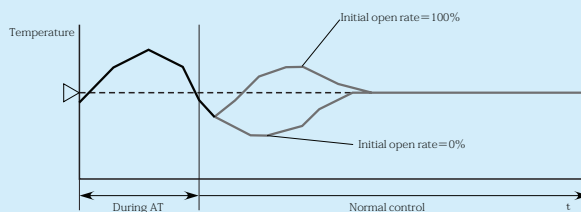

## ■ Ordering Information (Model Configurations)

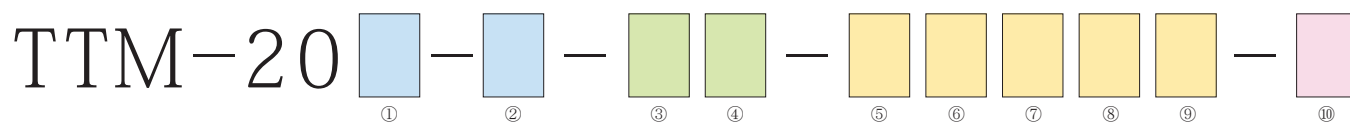

① Model	4	48×48		
	5	96×48		
	7	72×72		
	9	96×96		
② Case color	Q	Black		
	X	Gray		*6
③ Output 1	N	No	J	Voltage 0 to 5VDC
	R	Relay point of contact	F	Voltage 1 to 5VDC
	P	Voltage for SSR driving	G	Voltage 0 to 10VDC
	A	Open collector	I	Current 4 to 20mADC
	K	Voltage 0 to 1VDC	H	Voltage 0 to 10mVDC
④ Output 2	N	No	J	Voltage 0 to 5VDC
	R	Relay point of contact	F	Voltage 1 to 5VDC
	P	Voltage for SSR driving	G	Voltage 0 to 10VDC
	A	Open collector	I	Current 4 to 20mADC
	K	Voltage 0 to 1VDC	H	Voltage 0 to 10mVDC
⑤ Output 3, 4	A	Open collector		*4
	R	Relay point of contact		*4
⑥ Output 5, 6	A	Open collector		*2
	R	Relay point of contact		*2
⑦ Output 7	A	Open collector		*1·*3
	R	Relay point of contact (Independence)		
⑧ AI input	Y	Multiple input (Voltage/current only)		*1
⑨ Option (Plural selective possibilities)	S	CT1 input Measurement range: 0.0 to 50.0A		*5
	T	CT2 input Measurement range: 0.0 to 50.0A		*5
	U	Event 1 input		*5
	V	Event 2 input		*5
	W	Event 3, 4 input (Event 3 only available for TTM-207)		*1·*3
	M	Communications (RS-485)		
⑩ Power supply		Free power supply		
	L	24VAC/DC		

\*1 Not selectable for TTM-204

\*2 From output 5 to 7 are not selectable for TTM-204. Output 6 is not selectable for TTM-207.

\*3 Selectable either W (Event 3 only available) or output 7 for TTM-207.

\*4 Output 3 & 4 are common terminals for TTM-204, 205, 207 and 209.

\*5 Combination of ST, SV and UV are only available for TTM-204 and 207.

\*6 Not selectable for TTM-205, 207 and 209.



## TOHO ELECTRONICS INC.

Head Office: 1-13-21, Tanashioda, Sagami-hara Kanagawa 229-1125 Japan.  
Phone: +81-42-777-3311 FAX: +81-42-777-3751  
E-Mail: [overseas@toho-inc.co.jp](mailto:overseas@toho-inc.co.jp)  
Web site: <http://www.toho-inc.co.jp>

● Specifications are subject to change without notice.

Note: The color printed in this catalog may be different from actual color.